



# Cross Roller Guide/Ball Guide

THK General Catalog

## A Product Descriptions

<b>Features and Types</b> .....	A7-2
Features of the Cross Roller Guide/Ball Guide ..	A7-2
• Structure and Features .....	A7-2
Types of the Cross Roller Guide/Ball Guide ..	A7-3
• Types and Features .....	A7-3
<b>Point of Selection</b> .....	A7-4
Rated Load and Nominal Life .....	A7-4
Accuracy Standards .....	A7-7
<b>Dimensional Drawing, Dimensional Table</b>	
Cross Roller Guide Model VR (VR1) ..	A7-8
Cross Roller Guide Model VR (VR2) ..	A7-10
Cross Roller Guide Model VR (VR3) ..	A7-12
Cross Roller Guide Model VR (VR4) ..	A7-14
Cross Roller Guide Model VR (VR6) ..	A7-16
Cross Roller Guide Model VR (VR9) ..	A7-18
Cross Roller Guide Model VR (VR12) ..	A7-20
Cross Roller Guide Model VR (VR15) ..	A7-22
Cross Roller Guide Model VR (VR18) ..	A7-24
Ball Cage Model B .....	A7-26
<b>Point of Design</b> .....	A7-28
Installation Procedure .....	A7-28
Example of Clearance Adjustment ....	A7-29
Preload .....	A7-29
Accuracy of the Mounting Surface .....	A7-29
<b>Options</b> .....	A7-30
Dedicated Mounting Bolt .....	A7-30
<b>Model No.</b> .....	A7-31
• Model Number Coding .....	A7-31
• Notes on Ordering .....	A7-32
<b>Precautions on Use</b> .....	A7-33

## B Support Book (Separate)

<b>Features and Types</b> .....	B7-2
Features of the Cross Roller Guide/Ball Guide ..	B7-2
• Structure and Features .....	B7-2
Types of the Cross Roller Guide/Ball Guide ..	B7-3
• Types and Features .....	B7-3
<b>Point of Selection</b> .....	B7-4
Rated Load and Nominal Life .....	B7-4
<b>Mounting Procedure</b> .....	B7-7
Installation Procedure .....	B7-7
Example of Clearance Adjustment ....	B7-8
Preload .....	B7-8
Accuracy of the Mounting Surface .....	B7-8
<b>Options</b> .....	B7-9
Dedicated Mounting Bolt .....	B7-9
<b>Model No.</b> .....	B7-10
• Model Number Coding .....	B7-10
• Notes on Ordering .....	B7-11
<b>Precautions on Use</b> .....	B7-12

## Features of the Cross Roller Guide/Ball Guide

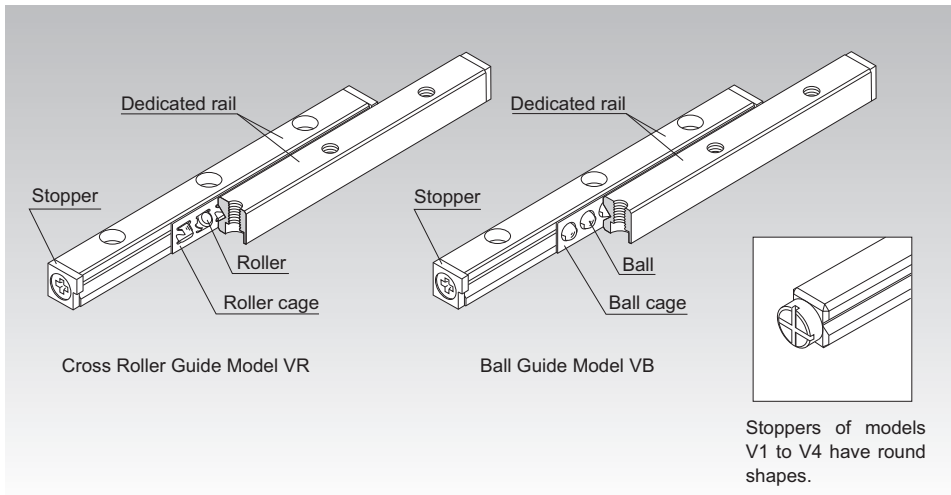

Fig.1 Structure of Cross Roller Guide Model VR and Ball Guide Model VB

### Structure and Features

In model VR, precision rollers are orthogonally aligned one after another in a roller cage that is combined with a dedicated rail having a raceway cut into a V-shape groove. When two units of the Cross Roller Guide are mounted in parallel, the guide system is capable of receiving loads in the four directions. In addition, since the Cross Roller Guide can be given a preload, a clearance-free, highly rigid and smooth slide mechanism is achieved.

Model VB is a low-friction, high-accuracy, finite LM system consisting of precision steel balls, arranged in short pitches in a ball cage model B, and a dedicated rail model V.

The Cross Roller Guide and the Ball Guide are used in the slide unit of various devices such as OA equipment and its peripherals, measuring instruments, precision equipment including a printed circuit board drilling machine, optic measuring machines, optic stages, handling mechanisms and X-Ray machines.

## Features and Types

### Types of the Cross Roller Guide/Ball Guide

#### [Long Service Life, High Rigidity]

With a unique roller retaining mechanism, the effective contact length of the rollers is 1.7 times greater than the conventional type. Furthermore, the roller pitch interval is short and a sufficient number of rollers are installed, thus increasing the rigidity by two and the service life by six times greater than the conventional type. As a result, a safety-oriented design against vibrations and impact, which commonly occur in ordinary straight motion mechanisms, can be achieved.

#### [Smooth Motion]

With model VR, the rollers are individually held in a cage and roller pockets formed on the cage are in surface contact with the rollers to increase grease retention. Thus, smooth motion with little wear and friction is achieved.

#### [Highly Corrosion Resistant]

Model VR series and model VB series both include types made of stainless steel, which is highly corrosion resistant.

## Types of the Cross Roller Guide/Ball Guide

### Types and Features

#### Cross Roller Guide Model VR

A compact, highly rigid LM system whose roller cage holding precision rollers orthogonally aligned one after another travels by half the stroke on a V-shaped groove formed on a rail.

Specification Table⇒ [A7-8](#)

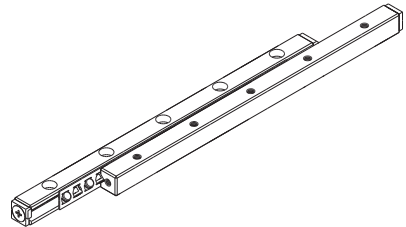

Model VR

#### Ball Guide Model VB

A low-friction, highly accurate LM system whose ball cage holding precision balls in short pitches travels by half the stroke on a V-shaped groove formed on a rail.

Specification Table⇒ [A7-26](#)

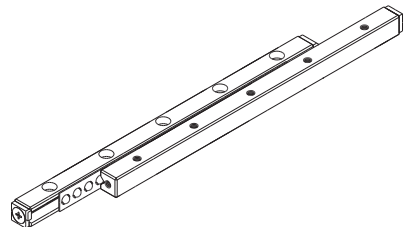

Model VB

## Rated Load and Nominal Life

### [Rated Loads in All Directions]

The basic load ratings ( $C_z$  and  $C_{0z}$ ) in the specification table indicate the values per rolling element in the directions shown in the figure. When obtaining the nominal life, calculate the basic load ratings ( $C$  and  $C_0$ ) of the actually used rolling elements from the equation below.

$C_z$  : Basic dynamic load rating per rolling element in the specification table (kN)

$C_{0z}$  : Basic static load rating per rolling element in the specification table (kN)

$Z$  : Number of rolling elements used (number of rolling elements within the effective load range)

$P$  : Roller pitch (Refer to pages **A7-8** to **A7-25**)

#### ● For Model VR

Load direction		
Basic dynamic load rating $C$ (kN)	$C = C_L = \left\{ \left( \frac{Z}{2} - 1 \right) \times 2P \right\}^{\frac{1}{36}} \times \left( \frac{Z}{2} \right)^3 \times C_z$	$C_T = 2^{\frac{7}{9}} \times \left\{ \left( \frac{Z}{2} - 1 \right) \times 2P \right\}^{\frac{1}{36}} \times \left( \frac{Z}{2} \right)^3 \times C_z$
Basic static load rating $C_0$ (kN)	$C_0 = C_{0L} = \frac{Z}{2} \times C_{0z}$	$C_{0T} = 2 \times \frac{Z}{2} \times C_{0z}$

\*For  $\frac{Z}{2}$ , truncate the decimals.

#### ● For Model VB

Load direction		
Basic dynamic load rating $C$ (kN)	$C = C_L = Z^{\frac{2}{3}} \times C_z$	$C_T = 2 \times Z^{\frac{2}{3}} \times C_z$
Basic static load rating $C_0$ (kN)	$C_0 = C_{0L} = Z \times C_{0z}$	$C_{0T} = 2 \times Z \times C_{0z}$

## Point of Selection

## Rated Load and Nominal Life

**[Static Safety Factor  $f_s$ ]**

Models VR and VB may receive an unexpected external force while it is stationary or operative due to the generation of an inertia caused by vibrations and impact or start and stop. It is necessary to consider a static safety factor against such a working load.

$$f_s = \frac{C_0}{P_c}$$

$f_s$  : Static safety factor (see Table1)  
 $C_0$  : Basic static load rating (kN)  
 $P_c$  : Calculated load (kN)

Table1 Reference Values of Static Safety Factor ( $f_s$ )

Machine using the LM system	Load conditions	Lower limit of $f_s$
General industrial machinery	Without vibration or impact	1 to 1.3
	With vibration or impact	2 to 3

**[Nominal Life]**

When the basic dynamic load ratings have been obtained, the rated lives of model VR and model VB are obtained using the following equations.

## ● For Model VR

$$L = \left( \frac{f_T}{f_w} \cdot \frac{C}{P_c} \right)^{10} \times 100$$

## ● For Model VB

$$L = \left( \frac{f_T}{f_w} \cdot \frac{C}{P_c} \right)^3 \times 50$$

$L$  : Nominal life (km)  
 (The total number of revolutions that 90% of a group of identical VR (VB) units independently operating under the same conditions can achieve without showing flaking)  
 $C$  : Basic dynamic load rating (kN)  
 $P_c$  : Calculated load (kN)  
 $f_T$  : Temperature factor (see Fig.1 on **A7-6**)  
 $f_w$  : Load factor (see Table2 on **A7-6**)

**[Calculating the Service Life Time]**

When the nominal life ( $L$ ) has been obtained, if the stroke length and the number of reciprocations per minute are constant, the service life time is obtained using the following equation.

$$L_h = \frac{L \times 10^6}{2 \times \ell_s \times n_1 \times 60}$$

$L_h$  : Service life time (h)  
 $\ell_s$  : Stroke length (mm)  
 $n_1$  : Number of reciprocations per minute ( $\text{min}^{-1}$ )

● **f<sub>r</sub>: Temperature Factor**

If the temperature of the environment surrounding the operating model VR or VB exceeds 100 °C, take into account the adverse effect of the high temperature and multiply the basic load ratings by the temperature factor indicated in Fig.1.

(Note) If the environment temperature exceeds 100°C, contact THK.

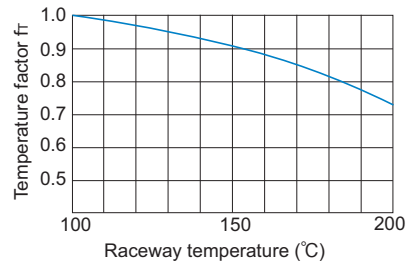

Fig.1 Temperature Factor (f<sub>r</sub>)

● **f<sub>w</sub>: Load Factor**

In general, reciprocating machines tend to involve vibrations or impact during operation. It is extremely difficult to accurately determine vibrations generated during high-speed operation and impact during frequent start and stop. Therefore, when the actual load applied on model VR or VB cannot be obtained, or when speed and vibrations have a significant influence, divide the basic load rating (C or C<sub>0</sub>), by the corresponding load factor in Table2 of empirically obtained data.

Table2 Load Factor (f<sub>w</sub>)

Vibrations/ impact	Speed (V)	f <sub>w</sub>
Faint	Very low $V \leq 0.25\text{m/s}$	1 to 1.2
Weak	Slow $0.25 < V \leq 1\text{m/s}$	1.2 to 1.5

# Accuracy Standards

The accuracy of the dedicated rail for the Cross Roller Guide is classified into high accuracy grade (H) and precision grade (P) as shown in Table3.

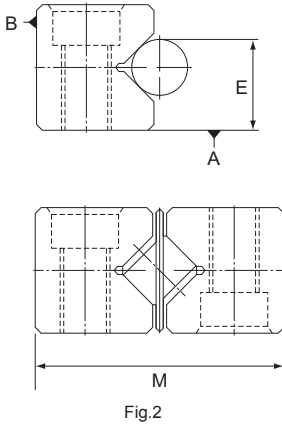

Table3 Accuracy Standards for Dedicated Rail Model V

Unit: mm

Accuracy grades	High-accuracy grade	Precision grade
Symbol	H	P
Item		
Parallelism of the raceway against surfaces A and B	As per Fig.3	
Dimensional tolerance in height E	$\pm 0.02$	$\pm 0.01$
Difference in height E <sup>(note)</sup>	0.01	0.005
Dimensional tolerance in width M	0 -0.2	0 -0.1

Note) The difference in height E applies to four rails used on the same plane.

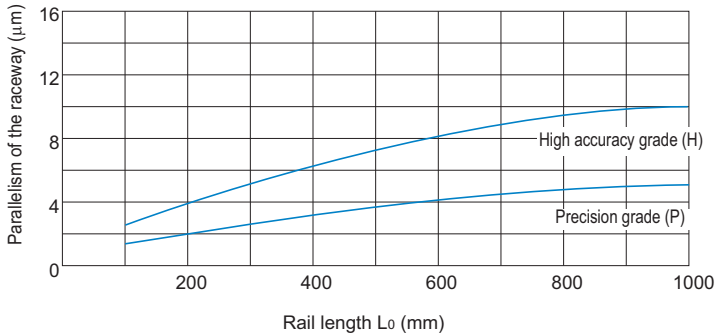
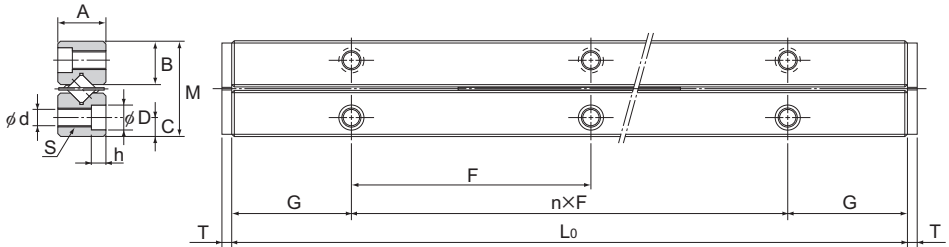

Fig.3 Rail Length and Parallelism of the Raceway

# Cross Roller Guide Model VR (VR1)



Model No.	Maximum stroke	Main								
		Combined dimensions			Mounting					
		M	A	L <sub>0</sub>	n×F	G	B	C	S	d
VR 1-20×5Z	12	8.5	4	20	1×10	5	3.9	1.8	M2	1.65
VR 1-30×7Z	22			30	2×10					
VR 1-40×10Z	27			40	3×10					
VR 1-50×13Z	32			50	4×10					
VR 1-60×16Z	37			60	5×10					
VR 1-70×19Z	42			70	6×10					
VR 1-80×21Z	52			80	7×10					

## Model number coding

**VR1 -30 H × 8Z**

Number of rollers or balls  
Accuracy symbol

Dedicated rail dimension in mm  
(example of indication for a combination of different overall lengths: 40/50)

Combined model number (for Ball Guide: VB)

Note) "One set" in the model No. above indicates a combination of four rails and two cages.



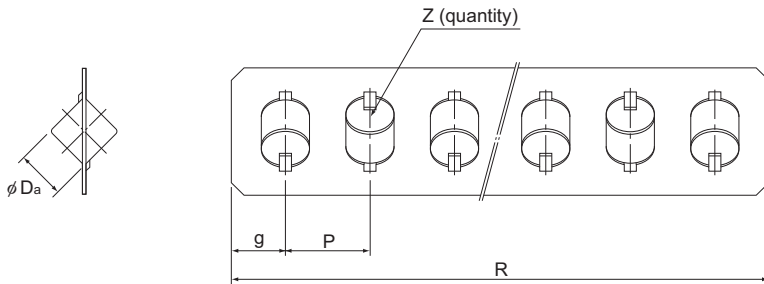

Unit: mm

dimensions								Permissible preload $\delta$ $\mu\text{m}$	Basic load rating (per roller)		Mass (rail) kg/m
dimensions									$C_z$ kN	$C_{oz}$ kN	
D	h	T	$D_a$	R	g	P	No. of rollers Z				
3	1.4	1.6	1.5	14	2	2.5	5	-2	0.152	0.153	0.11
				19			7				
				26.5			10				
				34			13				
				41.5			16				
				49			19				
				54			21				

Note) When desiring a Ball Guide in combination with a ball cage, refer to **A7-26** on Ball Cage Model B and indicate the required number of balls.

(Example) VB1-50H x  $\overset{\text{Number of balls}}{12Z}$

The mass in the table indicates the value per rail/m.

Stainless steel type with high corrosion resistance is also available. (symbol M, e.g., VR1M)

To fix the dedicated rail of model VR1, use cross-recessed screws for precision equipment (No. 0 screw).

Model No.	Type	Nominal name of screw $\times$ pitch
For model VR1	No. 0 pan-head screw (class 3)	M1.4 $\times$ 0.3

Japan Camera Industry Association Standard JCIS 10-70  
Cross-recessed screw for precision equipment (No. 0 screw)

## Cross Roller Guide Model VR (VR2)

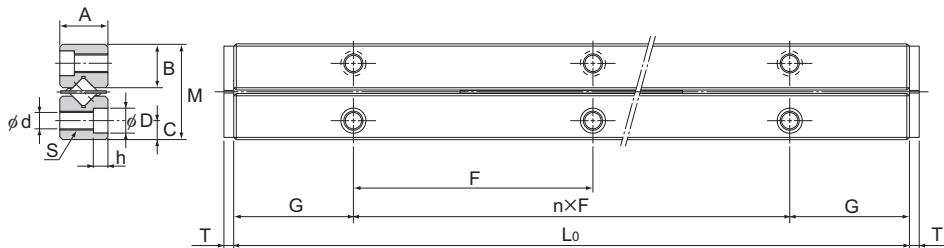

Model No.	Maximum stroke	Main								
		Combined dimensions			Mounting					
		M	A	L <sub>0</sub>	n×F	G	B	C	S	d
VR 2- 30×5Z	18	12	6	30	1×15	7.5	5.6	2.5	M3	2.55
VR 2- 45×8Z	24			45	2×15					
VR 2- 60×11Z	30			60	3×15					
VR 2- 75×13Z	44			75	4×15					
VR 2- 90×16Z	50			90	5×15					
VR 2-105×18Z	64			105	6×15					
VR 2-120×21Z	70			120	7×15					
VR 2-135×23Z	84			135	8×15					
VR 2-150×26Z	90			150	9×15					
VR 2-165×29Z	96			165	10×15					
VR 2-180×32Z	102			180	11×15					

### Model number coding

**VR2 -30 H × 6Z**

Number of rollers or balls  
Accuracy symbol

Dedicated rail dimension in mm  
(example of indication for a combination of different overall lengths: 90/105)

Combined model number (for Ball Guide: VB)

Note) "One set" in the model No. above indicates a combination of four rails and two cages.

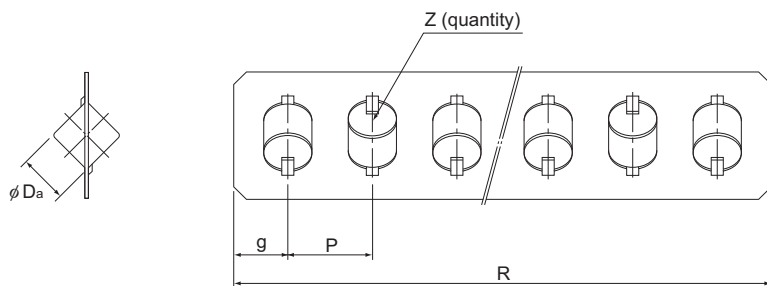

Unit: mm

dimensions								Permissible preload $\delta$ $\mu\text{m}$	Basic load rating (per roller)		Mass (rail) kg/m
dimensions							No. of rollers Z		$C_z$ kN	$C_{oz}$ kN	
D	h	T	$D_a$	R	g	P		Z			
4.4	2	1.5	2	21	2.5	4	5	-3	0.276	0.271	0.23
				33			8				
				45			11				
				53			13				
				65			16				
				73			18				
				85			21				
				93			23				
				105			26				
				117			29				
				129			32				

Note) When desiring a Ball Guide in combination with a ball cage, refer to **A7-26** on Ball Cage Model B and indicate the required number of balls.

(Example) VB2-90H x 15Z

Number of balls

The mass in the table indicates the value per rail/m.

Stainless steel type with high corrosion resistance is also available. (symbol M, e.g., VR2M)

To fix the dedicated rail of model VR2, use cross-recessed screws.

Model No.	Type	Nominal name of screw $\times$ pitch
For model VR2	Pan Head Screw	M2 $\times$ 0.4

Cross-recessed screw JIS B 1111 (pan head screw)

# Cross Roller Guide Model VR (VR3)

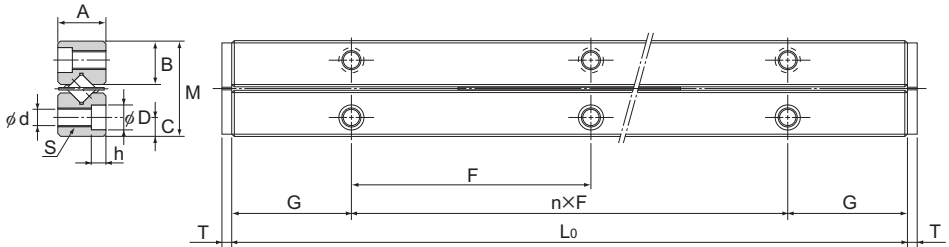

Model No.	Maximum stroke	Main								
		Combined dimensions			Mounting					
		M	A	L <sub>0</sub>	n×F	G	B	C	S	d
VR 3- 50×7Z	28	18	8	50	1×25	12.5	8.3	3.5	M4	3.3
VR 3- 75×10Z	48			75	2×25					
VR 3-100×14Z	58			100	3×25					
VR 3-125×17Z	78			125	4×25					
VR 3-150×21Z	88			150	5×25					
VR 3-175×24Z	108			175	6×25					
VR 3-200×28Z	118			200	7×25					
VR 3-225×31Z	138			225	8×25					
VR 3-250×35Z	148			250	9×25					
VR 3-275×38Z	168			275	10×25					
VR 3-300×42Z	178			300	11×25					

## Model number coding

**VR3 -75 H × 9Z**

Number of rollers or balls

Accuracy symbol

Dedicated rail dimension in mm

(example of indication for a combination of different overall lengths: 100/125)

Combined model number (for Ball Guide: VB)

Note) "One set" in the model No. above indicates a combination of four rails and two cages.

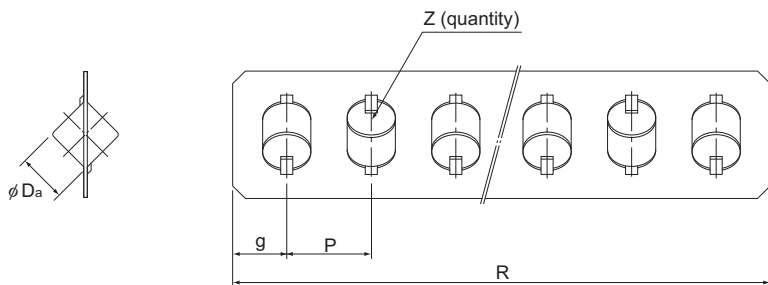

Unit: mm

dimensions								Permissible preload $\delta$ $\mu\text{m}$	Basic load rating (per roller)		Mass (rail) kg/m	
dimensions							No. of rollers Z		$C_z$ kN	$C_{0z}$ kN		
D	h	T	$D_a$	R	g	P						
6	3.1	2	3	36	3	3	5	7	-4	0.639	0.611	0.45
				51				10				
				71				14				
				86				17				
				106				21				
				121				24				
				141				28				
				156				31				
				176				35				
				191				38				
				211				42				

Note) When desiring a Ball Guide in combination with a ball cage, refer to **A7-26** on Ball Cage Model B and indicate the required number of balls.

(Example) VB3-150H x 20Z

Number of balls

The mass in the table indicates the value per rail/m.

Stainless steel type with high corrosion resistance is also available. (symbol M, e.g., VR3M)

# Cross Roller Guide Model VR (VR4)

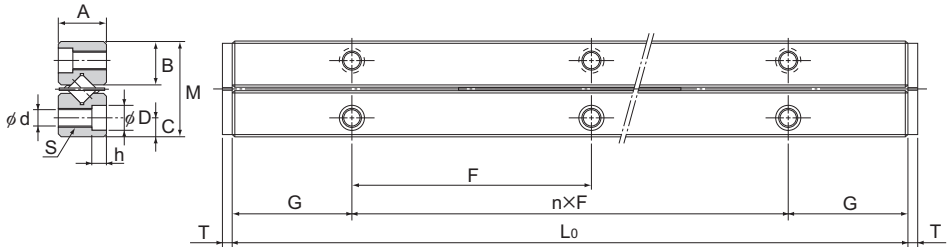

Model No.	Maximum stroke	Main								
		Combined dimensions			Mounting					
		M	A	L <sub>0</sub>	n×F	G	B	C	S	d
VR 4- 80×7Z	58	22	11	80	1×40	20	10.2	4.5	M5	4.3
VR 4-120×11Z	82			120	2×40					
VR 4-160×15Z	106			160	3×40					
VR 4-200×19Z	130			200	4×40					
VR 4-240×23Z	154			240	5×40					
VR 4-280×27Z	178			280	6×40					
VR 4-320×31Z	202			320	7×40					
VR 4-360×35Z	226			360	8×40					
VR 4-400×39Z	250			400	9×40					
VR 4-440×43Z	274			440	10×40					
VR 4-480×47Z	298			480	11×40					

## Model number coding

**VR4 -80 P × 9Z**

Number of rollers or balls  
Accuracy symbol

Dedicated rail dimension in mm  
(example of indication for a combination of different overall lengths: 120/160)

Combined model number (for Ball Guide: VB)

Note) "One set" in the model No. above indicates a combination of four rails and two cages.

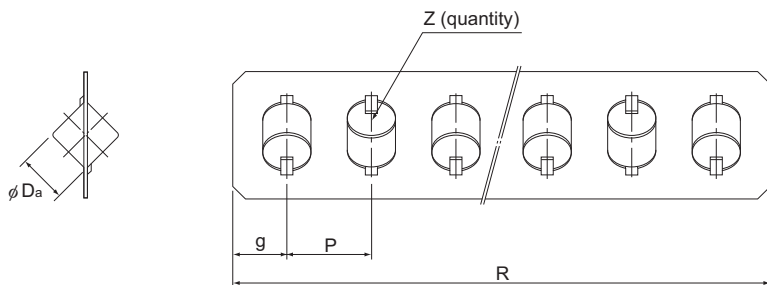

Unit: mm

dimensions								Permissible preload $\delta$ $\mu\text{m}$	Basic load rating (per roller)		Mass (rail) kg/m	
dimensions							No. of rollers Z		$C_z$ kN	$C_{0z}$ kN		
D	h	T	$D_a$	R	g	P						
8	4.2	2	4	51	4.5	7		7	-5	1.38	1.35	0.8
				79				11				
				107				15				
				135				19				
				163				23				
				191				27				
				219				31				
				247				35				
				275				39				
				303				43				
				331				47				

Note) When desiring a Ball Guide in combination with a ball cage, refer to **A7-26** on Ball Cage Model B and indicate the required number of balls.

(Example) VB4-200H x 17Z  
 └─── Number of balls

The mass in the table indicates the value per rail/m.

Stainless steel type with high corrosion resistance is also available. (symbol M, e.g., VR4M)

# Cross Roller Guide Model VR (VR6)

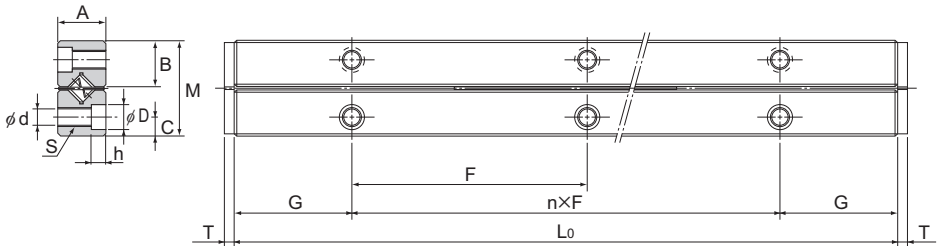

Model No.	Maximum stroke	Main								
		Combined dimensions			Mounting					
		M	A	L <sub>0</sub>	n×F	G	B	C	S	d
VR 6-100×7Z	56	30	15	100	1×50	25	14.4	6	M6	5.2
VR 6-150×10Z	96			150	2×50					
VR 6-200×13Z	136			200	3×50					
VR 6-250×17Z	156			250	4×50					
VR 6-300×20Z	196			300	5×50					
VR 6-350×24Z	216			350	6×50					
VR 6-400×27Z	256			400	7×50					
VR 6-450×31Z	276			450	8×50					
VR 6-500×34Z	316			500	9×50					
VR 6-550×38Z	336			550	10×50					
VR 6-600×41Z	376			600	11×50					

## Model number coding

**VR6 -100 P × 6Z**

Number of rollers or balls  
Accuracy symbol  
Dedicated rail dimension in mm  
(example of indication for a combination of different overall lengths: 300/400)

Combined model number (for Ball Guide: VB)

Note) "One set" in the model No. above indicates a combination of four rails and two cages.



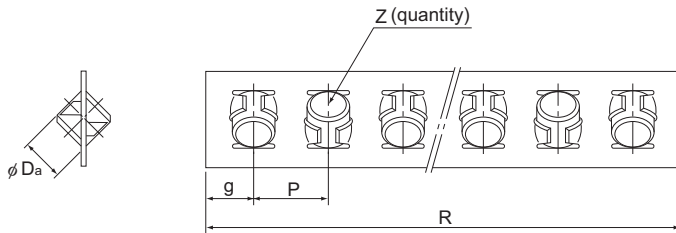

Unit: mm

dimensions								Permissible preload $\delta$ $\mu\text{m}$	Basic load rating (per roller)		Mass (rail) kg/m
dimensions				No. of rollers					$C_z$ kN	$C_{0z}$ kN	
D	h	T	$D_a$	R	g	P	Z				
9.5	5.2	3.2	6	72	6	10	7	-7	3.78	3.78	1.5
				102			10				
				132			13				
				172			17				
				202			20				
				242			24				
				272			27				
				312			31				
				342			34				
				382			38				
				412			41				

Note) When desiring a Ball Guide in combination with a ball cage, refer to **A7-26** on Ball Cage Model B and indicate the required number of balls.

(Example) VB6-300H x18Z

— Number of balls

The mass in the table indicates the value per rail/m.

Stainless steel type with high corrosion resistance is also available. (symbol M, e.g., VR6M)

# Cross Roller Guide Model VR (VR9)

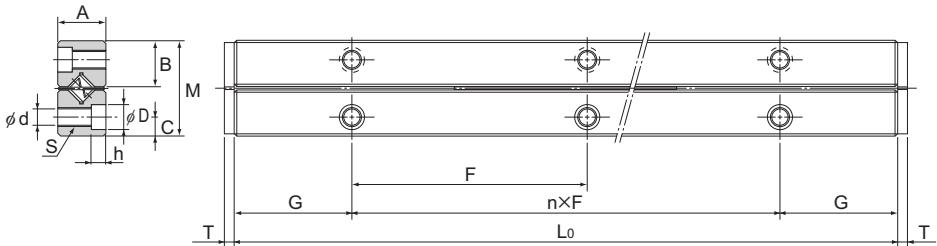

Model No.	Maximum stroke	Main								
		Combined dimensions			Mounting					
		M	A	L <sub>0</sub>	n×F	G	B	C	S	d
VR 9- 200×10Z	118	40 (40.74)	20	200	1×100	50	19.2	8	M8	6.8
VR 9- 300×15Z	178			300	2×100					
VR 9- 400×20Z	238			400	3×100					
VR 9- 500×25Z	298			500	4×100					
VR 9- 600×30Z	358			600	5×100					
VR 9- 700×35Z	418			700	6×100					
VR 9- 800×40Z	478			800	7×100					
VR 9- 900×45Z	538			900	8×100					
VR 9-1000×50Z	598			1000	9×100					
VR 9-1100×55Z	658			1100	10×100					
VR 9-1200×60Z	718			1200	11×100					

## Model number coding

**VR9 -600 H × 30Z**

Number of rollers or balls  
Accuracy symbol

Dedicated rail dimension in mm  
(example of indication for a combination of different overall lengths: 300/400)

Combined model number (for Ball Guide: VB)

Note) "One set" in the model No. above indicates a combination of four rails and two cages.

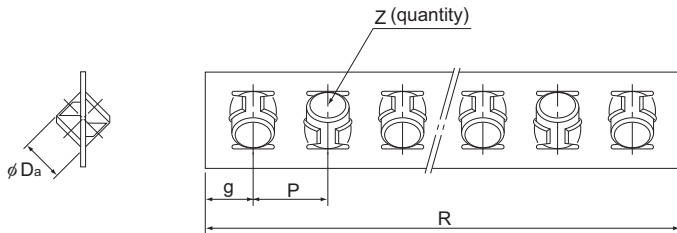

Unit: mm

dimensions								Permissible preload $\delta$ $\mu\text{m}$	Basic load rating (per roller)		Mass (rail) kg/m
dimensions							No. of rollers Z		$C_z$ kN	$C_{oz}$ kN	
D	h	T	$D_a$	R	g	P					
10.5	6.2	4	9 (9.525)	141	7.5	14	10	-10	9.53	9.48	3.2
				211			15				
				281			20				
				351			25				
				421			30				
				491			35				
				561			40				
				631			45				
				701			50				
				771			55				
				841			60				

Note) The dimensions in the parentheses above indicate the dimensions of the Ball Guide.

When desiring a Ball Guide in combination with a ball cage, refer to **A7-26** on Ball Cage Model B and indicate the required number of balls.

(Example) VB9-700H x 33Z

Number of balls

The mass in the table indicates the value per rail/m.

Stainless steel type with high corrosion resistance is also available. (symbol M, e.g., VR9M)

## Cross Roller Guide Model VR (VR12)

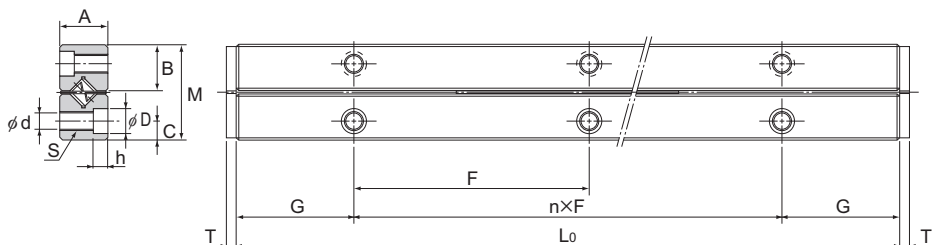

Model No.	Maximum stroke	Main								
		Combined dimensions			Mounting					
		M	A	L <sub>0</sub>	n×F	G	B	C	S	d
VR12-200×7Z	110	58 (57.86)	28	200	1×100	50	28	12	M10	8.5
VR12-300×10Z	190			300	2×100					
VR12-400×14Z	230			400	3×100					
VR12-500×17Z	310			500	4×100					
VR12-600×21Z	350			600	5×100					
VR12-700×24Z	430			700	6×100					
VR12-800×28Z	470			800	7×100					
VR12-900×31Z	550			900	8×100					
VR12-1000×34Z	630			1000	9×100					
VR12-1100×38Z	670			1100	10×100					
VR12-1200×41Z	750			1200	11×100					

### Model number coding

**VR12 -200 P × 9Z**

Number of rollers or balls  
Accuracy symbol

Dedicated rail dimension in mm  
(example of indication for a combination of different overall lengths: 300/400)

Combined model number (for Ball Guide: VB)

Note) "One set" in the model No. above indicates a combination of four rails and two cages.

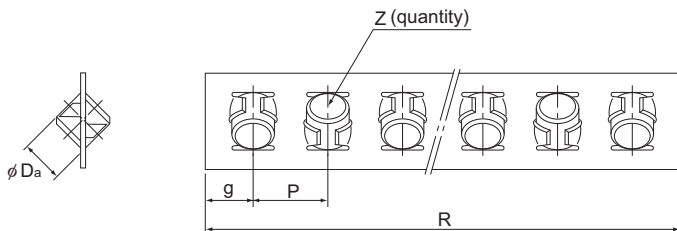

Unit: mm

dimensions								Permissible preload $\delta$ $\mu\text{m}$	Basic load rating (per roller)		Mass (rail) kg/m
dimensions							No. of rollers Z		$C_z$ kN	$C_{0z}$ kN	
D	h	T	$D_a$	R	g	P					
14	8.2	5	12 (11.906)	145	12.5	20	7	-13	17.6	17.2	5.3
				205			10				
				285			14				
				345			17				
				425			21				
				485			24				
				565			28				
				625			31				
				685			34				
				765			38				
				825			41				

Note) The dimensions in the parentheses above indicate the dimensions of the Ball Guide.

When desiring a Ball Guide in combination with a ball cage, refer to **A7-26** on Ball Cage Model B and indicate the required number of balls.

(Example) VB12-700H x 20Z

Number of balls

The mass in the table indicates the value per rail/m.

Stainless steel type with high corrosion resistance is also available. (symbol M, e.g., VR12M)

# Cross Roller Guide Model VR (VR15)

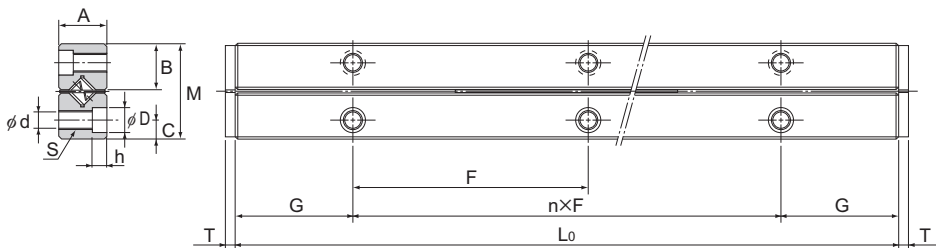

Model No.	Maximum stroke	Main								
		Combined dimensions			Mounting					
		M	A	L <sub>0</sub>	n×F	G	B	C	S	d
VR15- 300× 8Z	190	71 (71.11)	36	300	2×100	50	34.4	14	M12	10.5
VR15- 400×11Z	240			400	3×100					
VR15- 500×13Z	340			500	4×100					
VR15- 600×16Z	390			600	5×100					
VR15- 700×19Z	440			700	6×100					
VR15- 800×22Z	490			800	7×100					
VR15- 900×25Z	540			900	8×100					
VR15-1000×27Z	640			1000	9×100					
VR15-1100×30Z	690			1100	10×100					
VR15-1200×33Z	740			1200	11×100					

## Model number coding

**VR15 -300 H × 10Z**

Number of rollers or balls

Accuracy symbol

Dedicated rail dimension in mm

(example of indication for a combination of different overall lengths: 300/400)

Combined model number (for Ball Guide: VB)

Note) "One set" in the model No. above indicates a combination of four rails and two cages.

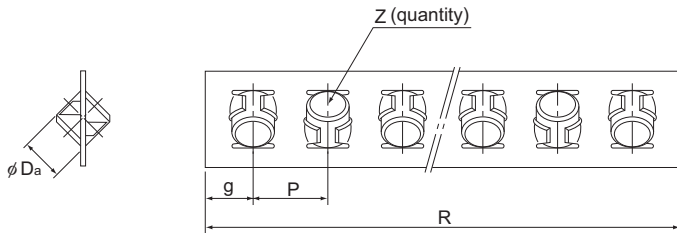

Unit: mm

dimensions								Permissible preload $\delta$ $\mu\text{m}$	Basic load rating (per roller)		Mass (rail) kg/m
dimensions							No. of rollers Z		$C_z$ kN	$C_{0z}$ kN	
D	h	T	$D_a$	R	g	P					
17.5	10.2	6	15 (15.081)	15	25	205	8	-16	27.9	26.8	8.3
						280	11				
						330	13				
						405	16				
						480	19				
						555	22				
						630	25				
						680	27				
						755	30				
						830	33				

Note) The dimensions in the parentheses above indicate the dimensions of the Ball Guide.  
When desiring a Ball Guide in combination with a ball cage, refer to **A7-26** on Ball Cage Model B and indicate the required number of balls.

(Example) VB15-800H x 20Z  
└─── Number of balls

The mass in the table indicates the value per rail/m.  
Stainless steel type with high corrosion resistance is also available. (symbol M, e.g., VR15M)

# Cross Roller Guide Model VR (VR18)

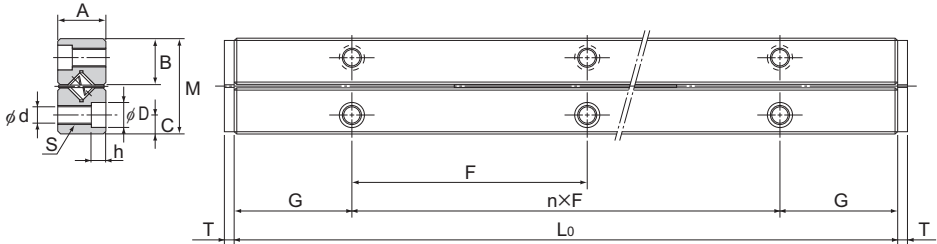

Model No.	Maximum stroke	Main								
		Combined dimensions			Mounting					
		M	A	L <sub>0</sub>	n×F	G	B	C	S	d
VR18-300×6Z	228	83	40	300	2×100	50	40.2	18	M14	12.5
VR18-400×9Z	248			400	3×100					
VR18-500×11Z	328			500	4×100					
VR18-600×13Z	408			600	5×100					
VR18-700×16Z	428			700	6×100					
VR18-800×18Z	508			800	7×100					
VR18-900×20Z	588			900	8×100					
VR18-1000×23Z	608			1000	9×100					
VR18-1100×25Z	688			1100	10×100					
VR18-1200×27Z	768			1200	11×100					

## Model number coding

**VR18 -400 H × 10Z**

Number of rollers or balls  
Accuracy symbol

Dedicated rail dimension in mm  
(example of indication for a combination of different overall lengths: 300/400)

Combined model number (for Ball Guide: VB)

Note) "One set" in the model No. above indicates a combination of four rails and two cages.



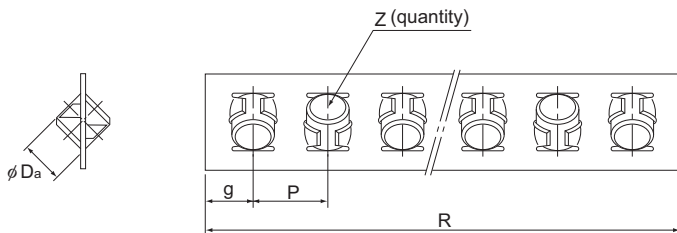

Unit: mm

dimensions								Permissible preload $\delta$ $\mu\text{m}$	Basic load rating (per roller)		Mass (rail) kg/m
dimensions							No. of rollers Z		$C_z$ kN	$C_{0z}$ kN	
D	h	T	$D_a$	R	g	P					
20	12.2	6	18	186	18	30	6	-18	40.9	38.8	10.5
				276			9				
				336			11				
				396			13				
				486			16				
				546			18				
				606			20				
				696			23				
				756			25				
				816			27				

Note) The mass in the table indicates the value per rail/m.  
Stainless steel type with high corrosion resistance is also available. (symbol M, e.g., VR18M)

## Ball Cage Model B

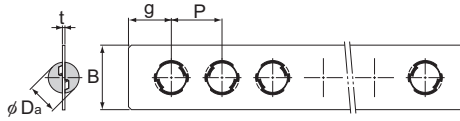

Unit: mm

Model No.	Main dimensions					Basic load rating (per ball)		Combined rail
	$D_a$	t	B	P	g	$C_z$ N	$C_{oz}$ N	
B 1	1.5	0.2	3.5	2.5	2	7.84	21.6	V1
B 2	2	0.3	5	4	3	12.7	39.2	V2
B 3	3	0.4	7	6	4.5	27.5	87.3	V3
B 4	4	0.5	9	7	4.5	45.1	155	V4
B 6	6	0.6	13.5	10	6	98	353	V6
B 9	9.525	1	19	14	8.5	216	784	V9
B 12	11.906	1	25	20	12.5	324	1420	V12
B 15	15.081	1.2	31	25	15	490	2160	V15



## Installation Procedure

When using clearance adjustment bolts:

(1) Closely contact rails 2 and 3 onto the base, and rail 1 onto the table, and then firmly tighten the rail mounting bolts.

(2) Temporarily fasten rail 4 to the table.

Note) The rail mounting bolts must be designed so that they can be fully fastened while maintaining the rail installed.

(3) Place the base and the tables as shown in Fig.1, and then insert the roller cage from the end. If the cage does not enter because there is no clearance, slide rail 4 toward the adjustment bolt first, and then insert the cage again.

(4) Place a dial gauge as shown in Fig.1. Then, lightly screw all adjustment bolts evenly until the clearance is almost eliminated while gently pressing the table sideways.

(5) Attach the stopper to the rail end.

(6) Slide the table and adjust the cage position so as to achieve the required stroke.

(7) Position the roller cage in the center of the rail as shown in Fig.2-1. Then, evenly tighten the adjustment bolts (b, c and d) that are within the area where the roller is present until the dial gauge indicates the required displacement. Fully fasten the mounting bolts where adjustment was performed.

Note) The displacement indicated on the gauge represents the preload per roller cage.

(8) Slide the table as shown in Fig.2-2, and adjust the remaining adjustment bolts (a and e) in the same manner.

Note) When installing two or more units, first measure the tightening torque of the adjustment bolts for the first unit or the sliding resistance of the first unit. Then, install the second (and later) unit so that its/their tightening torque(s) or sliding resistance(s) equal(s) that of the first unit. In this way, almost uniform preloads can be provided.

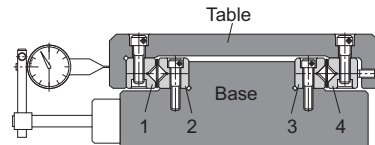

Fig.1 Installation of the Cross Roller Guide

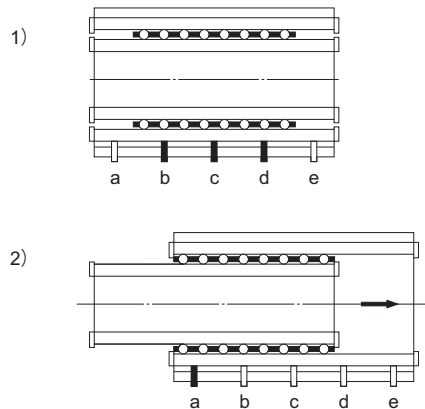
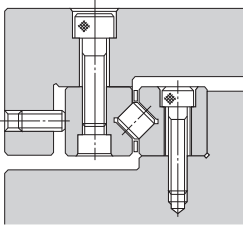

Fig.2 Sequence of Tightening the Adjustment Bolts

## Example of Clearance Adjustment

Design the adjustment bolt so that it presses the rail on the same level as the roller.



Normally, press the rail with the adjustment bolt.

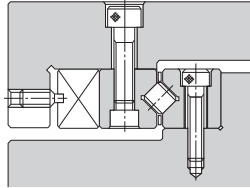

When a certain level of accuracy and rigidity is required, use a presser plate.

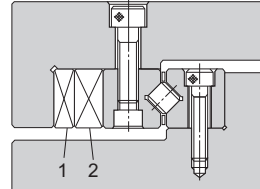

When high accuracy and high rigidity are required, use tapered gibs 1 and 2.

Fig.3 Example of Clearance Adjustment

## Preload

An excessive preload may cause indentation, shorten the service life or cause trouble. The permissible preload per roller cage is indicated in the specification table. Tighten the adjustment bolts while monitoring the displacement of the roller contact area.

## Accuracy of the Mounting Surface

To achieve a high level of running accuracy, it is also necessary to establish a certain level of accuracy in parallelism and straightness. Preferably, the parallelism and the flatness of the rail-mounting surface should be finished by grinding or similar machining to at least the same degree as the parallelism of the rail (see **A7-7**). Also, mount the rail so that it closely contacts the mounting surface.

## Dedicated Mounting Bolt

To mount the rail where normal clearance is to be adjusted, use the screw hole drilled on the rail as shown in Fig.1. The holes of the bolt ( $d_1$  and  $D_1$ ) must be machined so that they are greater by the adjustment allowance.

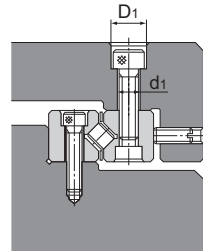

Fig.1

If it is inevitable to adopt a mounting method like the one shown in Fig.2 for a structural reason, use the dedicated mounting bolt (S) indicated in Fig.3.

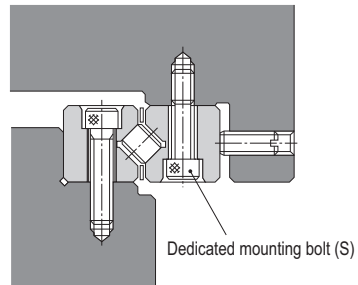

Fig.2

Table1 Dedicated Mounting Bolt

Unit: mm

Model No.	S	d	D	H	L	B	Mass [g]	Supported rail
S 3	M3	2.3	5	3	12	2.5	1	V3
S 4	M4	3.1	5.8	4	15	3	2	V4
S 6	M5	3.9	8	5	20	4	4	V6
S 9	M6	4.6	8.5	6	30	5	5	V9
S 12	M8	6.25	11.3	8	40	6	15	V12
S 15	M10	7.9	13.9	10	45	8	27	V15
S 18	M12	9.6	15.8	12	50	10	43	V18

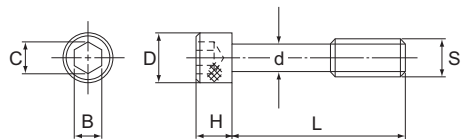

Fig.3 Dedicated Mounting Bolt

## Model Number Coding

Model number configurations differ depending on the model features. Refer to the corresponding sample model number configuration.

### [Cross Roller Guide/Ball Guide]

#### ● Models VR and VB

**VR1 M -30 H × 8Z**

No Symbol:

Carbon steel  
(standard)

M: Stainless steel

H : High accuracy grade

P : Precision grade

Number of rollers or balls

Dedicated rail dimension in mm (example of indication for a combination of different overall lengths: 40/50)

Combined model number (for Ball Guide: VB)

Note) "One set" in the model No. above indicates a combination of four rails and two cages.

- Dedicated rail only

**V6 -200**

Model No. Dedicated rail dimension in mm

- Roller cage only

**R6 × 13Z**

Model number Number of rollers or balls  
(Roller : R  
Ball : B)

- Dedicated mounting bolt

**S6**

Model No. For the compatibility chart, see **A7-30**

## Notes on Ordering

### [Order units]

“One set” of cross roller guides or ball guides denotes a combination of four rails and two cages.

### ● Sample cross roller guide and ball guide orders

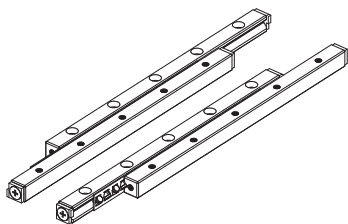

VR12 -400 P × 14Z 1 set

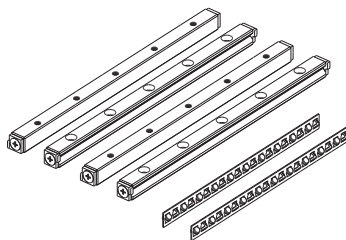

1 set consists of 4 rails and 2 cages

Note) For information on rail and cage product combinations other than those listed in the specification tables, contact THK.



**[Handling]**

- (1) Do not disassemble the parts. This will result in loss of functionality.
- (2) Take care not to drop or strike the Cross Roller Guide/Ball Guide. Doing so may cause injury or damage. Giving an impact to it could also cause damage to its function even if the product looks intact.
- (3) When handling the product, wear protective gloves, safety shoes, etc., as necessary to ensure safety.

**[Precautions on Use]**

- (1) Prevent foreign material, such as cutting chips or coolant, from entering the product. Failure to do so may cause damage.
- (2) If the product is used in an environment where cutting chips, corrosive solvents, water, etc., may enter the product, use bellows, covers, etc., to prevent them from entering the product.
- (3) If foreign material such as cutting chips adheres to the product, replenish the lubricant after cleaning the product.
- (4) Do not use the product at temperature of 100°C or higher.
- (5) Micro-strokes tend to obstruct oil film to form on the raceway in contact with the rolling element, and may lead to fretting corrosion. Take consideration using grease offering excellent fretting prevention. THK also recommends periodically executing a full stroke with the unit to ensure that the raceway and balls are coated with lubricant.
- (6) Do not use undue force when fitting parts (pin, key, etc.) to the product. This may generate permanent deformation on the raceway, leading to loss of functionality.
- (7) Using the product with some of the rolling elements missing may cause damage at an early stage.
- (8) If any of the rolling elements falls, contact THK instead of using the product.
- (9) Insufficient rigidity or accuracy of mounting members causes the bearing load to concentrate on one point and the bearing performance will drop significantly. Accordingly, give sufficient consideration to the rigidity/accuracy of the housing and base and strength of the fixing bolts.

**[Lubrication]**

- (1) Thoroughly wipe off anti-rust oil and feed lubricant before using the product.
- (2) When lubricating the product, apply grease directly on the raceway and stroke the product several times to let the grease spread inside.
- (3) Do not mix different lubricants. Mixing greases using the same type of thickening agent may still cause adverse interaction between the two greases if they use different additives, etc.
- (4) When using the product in locations exposed to constant vibrations or in special environments such as clean rooms, vacuum and low/high temperature, use the grease appropriate for the specification/environment.
- (5) The consistency of grease changes according to the temperature. Take note that the slide resistance of the Cross Roller Guide/Ball Guide also changes as the consistency of grease changes.
- (6) After lubrication, the slide resistance of the Cross Roller Guide/Ball Guide may increase due to the agitation resistance of grease. Be sure to perform a break-in to let the grease spread fully, before operating the machine.
- (7) Excess grease may scatter immediately after lubrication, so wipe off scattered grease as necessary.

- (8) The properties of grease deteriorate and its lubrication performance drops over time, so grease must be checked and added properly according to the use frequency of the machine.
- (9) The greasing interval varies depending on the use condition and service environment. Set the final lubrication interval/amount based on the actual machine.

### [Installation]

If the counterbore hole on the Cross Roller Guide is being used to anchor the rail, use a hexagonal-head bolt (JIS B 1176). However, for the models listed in Table1, THK's recommendations for screws are shown.

Table1 Anchoring screws

Model	Type	Nominal name of screw × pitch
VR1	No. 0 pan-head screw (class 3)	M1.4×0.3
VR2	Pan Head Screw	M2×0.4

- Japan Camera Industry Association Standard JCIS 10-70 Phillips screw for precision equipment (No. 0 screw)
- Phillips pan head screw JIS B 1111

### [Rail Length]

The roller cage and the ball cage move half the travel distance of the table in the same direction.

To prevent the cage from overhanging from the raceway base when the cage length is " $l$ " and the stroke length is " $l_s$ ", the rail length ( $L_k$ ) must be at least the following.

$$L_k \geq l + \frac{l_s}{2}$$

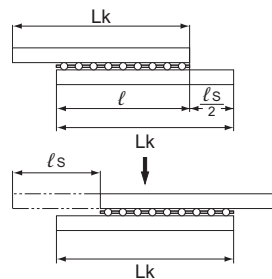

Fig.1

### [Offset of the Cage]

The cage, which retains rollers (or balls), demonstrates extremely accurate motion. However, it may be offset as affected by driving vibrations, inertia or impact.

When desiring to use the product in a following condition, contact THK.

- Vertical use
- Pneumatic cylinder drive
- Cam drive
- High speed crank drive
- Under a large moment load
- Butting the guide's external stopper with the table

**[Stopper]**

Stoppers are attached to the rail ends in order to prevent the cage from falling off. Note, however, that frequently colliding the cage with the stopper may cause wear of the stopper and loosening of the stopper fastening screws, and may cause the cage to fall off.

**[Contamination protection]**

As a means to prevent foreign material from entering the Cross Roller Guide or the Ball Guide, contamination protection accessories for the side faces as shown in Fig.2 are available. For contamination protection in the front and rear directions, consider using a bellows or a telescopic cover.

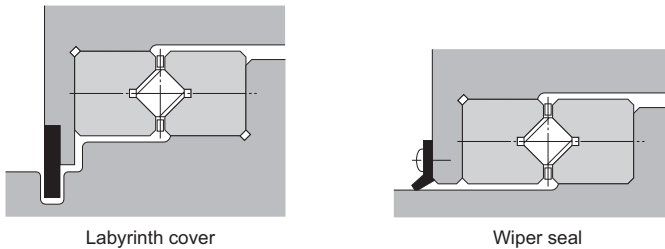

Fig.2 Contamination Protection Methods

**[Storage]**

When storing the Cross Roller Guide•Ball Guide, enclose it in a package designated by THK and store it in a room in a horizontal orientation while avoiding high temperature, low temperature and high humidity.

**[Disposal]**

Dispose of the product properly as industrial waste.





# Cross Roller Guide/Ball Guide

THK General Catalog

## B Support Book

<b>Features and Types</b> .....	A7-2
Features of the Cross Roller Guide/Ball Guide ..	A7-2
• Structure and Features .....	A7-2
Types of the Cross Roller Guide/Ball Guide ..	A7-3
• Types and Features .....	A7-3
<b>Point of Selection</b> .....	A7-4
Rated Load and Nominal Life .....	A7-4
<b>Mounting Procedure</b> .....	A7-7
Installation Procedure .....	A7-7
Example of Clearance Adjustment ....	A7-8
Preload .....	A7-8
Accuracy of the Mounting Surface.....	A7-8
<b>Options</b> .....	A7-9
Dedicated Mounting Bolt .....	A7-9
<b>Model No.</b> .....	A7-10
• Model Number Coding .....	A7-10
• Notes on Ordering .....	A7-11
<b>Precautions on Use</b> .....	A7-12

## A Product Descriptions (Separate)

<b>Features and Types</b> .....	A7-2
Features of the Cross Roller Guide/Ball Guide ..	A7-2
• Structure and Features .....	A7-2
Types of the Cross Roller Guide/Ball Guide ..	A7-3
• Types and Features .....	A7-3
<b>Point of Selection</b> .....	A7-4
Rated Load and Nominal Life .....	A7-4
Accuracy Standards .....	A7-7
<b>Dimensional Drawing, Dimensional Table</b>	
Cross Roller Guide Model VR (VR1) ..	A7-8
Cross Roller Guide Model VR (VR2) ..	A7-10
Cross Roller Guide Model VR (VR3) ..	A7-12
Cross Roller Guide Model VR (VR4) ..	A7-14
Cross Roller Guide Model VR (VR6) ..	A7-16
Cross Roller Guide Model VR (VR9) ..	A7-18
Cross Roller Guide Model VR (VR12) ..	A7-20
Cross Roller Guide Model VR (VR15) ..	A7-22
Cross Roller Guide Model VR (VR18) ..	A7-24
Ball Cage Model B .....	A7-26
<b>Point of Design</b> .....	A7-28
Installation Procedure .....	A7-28
Example of Clearance Adjustment ....	A7-29
Preload .....	A7-29
Accuracy of the Mounting Surface.....	A7-29
<b>Options</b> .....	A7-30
Dedicated Mounting Bolt .....	A7-30
<b>Model No.</b> .....	A7-31
• Model Number Coding .....	A7-31
• Notes on Ordering .....	A7-32
<b>Precautions on Use</b> .....	A7-33

## Features of the Cross Roller Guide/Ball Guide

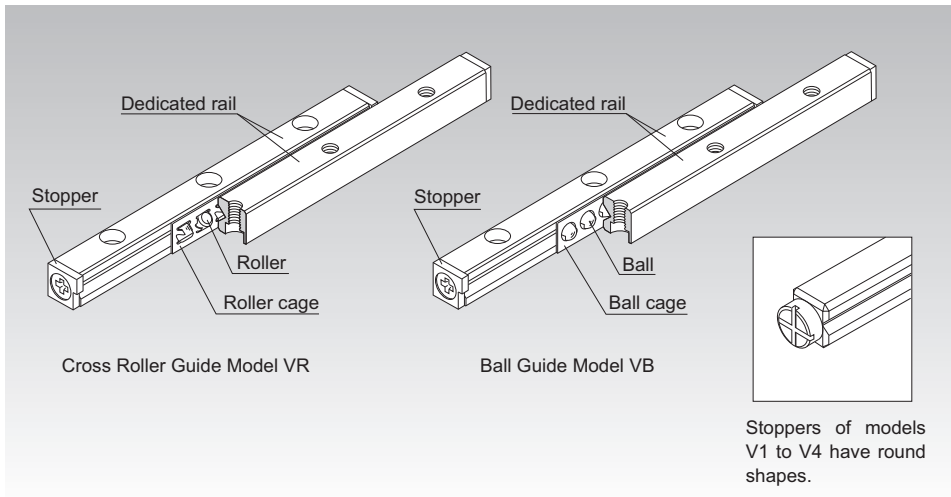

Fig.1 Structure of Cross Roller Guide Model VR and Ball Guide Model VB

### Structure and Features

In model VR, precision rollers are orthogonally aligned one after another in a roller cage that is combined with a dedicated rail having a raceway cut into a V-shape groove. When two units of the Cross Roller Guide are mounted in parallel, the guide system is capable of receiving loads in the four directions. In addition, since the Cross Roller Guide can be given a preload, a clearance-free, highly rigid and smooth slide mechanism is achieved.

Model VB is a low-friction, high-accuracy, finite LM system consisting of precision steel balls, arranged in short pitches in a ball cage model B, and a dedicated rail model V.

The Cross Roller Guide and the Ball Guide are used in the slide unit of various devices such as OA equipment and its peripherals, measuring instruments, precision equipment including a printed circuit board drilling machine, optic measuring machines, optic stages, handling mechanisms and X-Ray machines.

## Features and Types

### Types of the Cross Roller Guide/Ball Guide

#### [Long Service Life, High Rigidity]

With a unique roller retaining mechanism, the effective contact length of the rollers is 1.7 times greater than the conventional type. Furthermore, the roller pitch interval is short and a sufficient number of rollers are installed, thus increasing the rigidity by two and the service life by six times greater than the conventional type. As a result, a safety-oriented design against vibrations and impact, which commonly occur in ordinary straight motion mechanisms, can be achieved.

#### [Smooth Motion]

With model VR, the rollers are individually held in a cage and roller pockets formed on the cage are in surface contact with the rollers to increase grease retention. Thus, smooth motion with little wear and friction is achieved.

#### [Highly Corrosion Resistant]

Model VR series and model VB series both include types made of stainless steel, which is highly corrosion resistant.

## Types of the Cross Roller Guide/Ball Guide

### Types and Features

#### Cross Roller Guide Model VR

A compact, highly rigid LM system whose roller cage holding precision rollers orthogonally aligned one after another travels by half the stroke on a V-shaped groove formed on a rail.

Specification Table⇒ [A7-8](#)

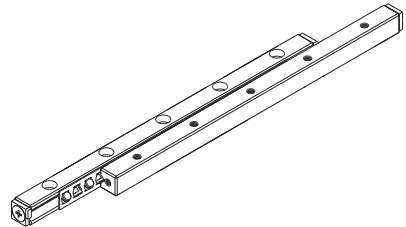

Model VR

#### Ball Guide Model VB

A low-friction, highly accurate LM system whose ball cage holding precision balls in short pitches travels by half the stroke on a V-shaped groove formed on a rail.

Specification Table⇒ [A7-26](#)

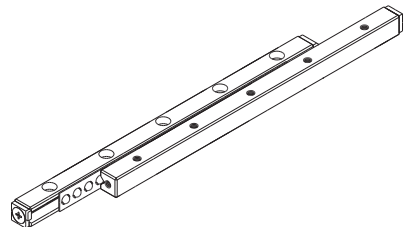

Model VB

## Rated Load and Nominal Life

### [Rated Loads in All Directions]

The basic load ratings ( $C_z$  and  $C_{0z}$ ) in the specification table indicate the values per rolling element in the directions shown in the figure. When obtaining the nominal life, calculate the basic load ratings ( $C$  and  $C_0$ ) of the actually used rolling elements from the equation below.

$C_z$  : Basic dynamic load rating per rolling element in the specification table (kN)

$C_{0z}$  : Basic static load rating per rolling element in the specification table (kN)

$Z$  : Number of rolling elements used (number of rolling elements within the effective load range)

$P$  : Roller pitch (Refer to pages **A7-8** to **A7-25**)

#### ● For Model VR

Load direction		
Basic dynamic load rating $C$ (kN)	$C = C_L = \left\{ \left( \frac{Z}{2} - 1 \right) \times 2P \right\}^{\frac{1}{36}} \times \left( \frac{Z}{2} \right)^3 \times C_z$	$C_T = 2^{\frac{7}{9}} \times \left\{ \left( \frac{Z}{2} - 1 \right) \times 2P \right\}^{\frac{1}{36}} \times \left( \frac{Z}{2} \right)^3 \times C_z$
Basic static load rating $C_0$ (kN)	$C_0 = C_{0L} = \frac{Z}{2} \times C_{0z}$	$C_{0T} = 2 \times \frac{Z}{2} \times C_{0z}$

\*For  $\frac{Z}{2}$ , truncate the decimals.

#### ● For Model VB

Load direction		
Basic dynamic load rating $C$ (kN)	$C = C_L = Z^{\frac{2}{3}} \times C_z$	$C_T = 2 \times Z^{\frac{2}{3}} \times C_z$
Basic static load rating $C_0$ (kN)	$C_0 = C_{0L} = Z \times C_{0z}$	$C_{0T} = 2 \times Z \times C_{0z}$



## Point of Selection

### Rated Load and Nominal Life

#### [Static Safety Factor $f_s$ ]

Models VR and VB may receive an unexpected external force while it is stationary or operative due to the generation of an inertia caused by vibrations and impact or start and stop. It is necessary to consider a static safety factor against such a working load.

$$f_s = \frac{C_0}{P_c}$$

$f_s$  : Static safety factor (see Table1)  
 $C_0$  : Basic static load rating (kN)  
 $P_c$  : Calculated load (kN)

Table1 Reference Values of Static Safety Factor ( $f_s$ )

Machine using the LM system	Load conditions	Lower limit of $f_s$
General industrial machinery	Without vibration or impact	1 to 1.3
	With vibration or impact	2 to 3

#### [Nominal Life]

When the basic dynamic load ratings have been obtained, the rated lives of model VR and model VB are obtained using the following equations.

##### ● For Model VR

$$L = \left( \frac{f_T}{f_w} \cdot \frac{C}{P_c} \right)^{10} \times 100$$

##### ● For Model VB

$$L = \left( \frac{f_T}{f_w} \cdot \frac{C}{P_c} \right)^3 \times 50$$

$L$  : Nominal life (km)  
 (The total number of revolutions that 90% of a group of identical VR (VB) units independently operating under the same conditions can achieve without showing flaking)  
 $C$  : Basic dynamic load rating (kN)  
 $P_c$  : Calculated load (kN)  
 $f_T$  : Temperature factor (see Fig.1 on [B7-6](#))  
 $f_w$  : Load factor (see Table2 on [B7-6](#))

#### [Calculating the Service Life Time]

When the nominal life ( $L$ ) has been obtained, if the stroke length and the number of reciprocations per minute are constant, the service life time is obtained using the following equation.

$$L_h = \frac{L \times 10^6}{2 \times \ell_s \times n_1 \times 60}$$

$L_h$  : Service life time (h)  
 $\ell_s$  : Stroke length (mm)  
 $n_1$  : Number of reciprocations per minute ( $\text{min}^{-1}$ )

● **f<sub>r</sub>: Temperature Factor**

If the temperature of the environment surrounding the operating model VR or VB exceeds 100 °C, take into account the adverse effect of the high temperature and multiply the basic load ratings by the temperature factor indicated in Fig.1.

(Note) If the environment temperature exceeds 100°C, contact THK.

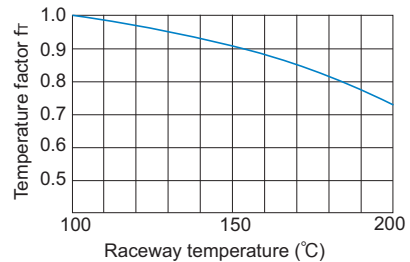

Fig.1 Temperature Factor (f<sub>r</sub>)

● **f<sub>w</sub>: Load Factor**

In general, reciprocating machines tend to involve vibrations or impact during operation. It is extremely difficult to accurately determine vibrations generated during high-speed operation and impact during frequent start and stop. Therefore, when the actual load applied on model VR or VB cannot be obtained, or when speed and vibrations have a significant influence, divide the basic load rating (C or C<sub>0</sub>), by the corresponding load factor in Table2 of empirically obtained data.

Table2 Load Factor (f<sub>w</sub>)

Vibrations/ impact	Speed (V)	f <sub>w</sub>
Faint	Very low $V \leq 0.25\text{m/s}$	1 to 1.2
Weak	Slow $0.25 < V \leq 1\text{m/s}$	1.2 to 1.5

## Installation Procedure

When using clearance adjustment bolts:

- (1) Closely contact rails 2 and 3 onto the base, and rail 1 onto the table, and then firmly tighten the rail mounting bolts.

- (2) Temporarily fasten rail 4 to the table.

Note) The rail mounting bolts must be designed so that they can be fully fastened while maintaining the rail installed.

- (3) Place the base and the tables as shown in Fig.1, and then insert the roller cage from the end. If the cage does not enter because there is no clearance, slide rail 4 toward the adjustment bolt first, and then insert the cage again.

- (4) Place a dial gauge as shown in Fig.1. Then, lightly screw all adjustment bolts evenly until the clearance is almost eliminated while gently pressing the table sideways.

- (5) Attach the stopper to the rail end.

- (6) Slide the table and adjust the cage position so as to achieve the required stroke.

- (7) Position the roller cage in the center of the rail as shown in Fig.2-1. Then, evenly tighten the adjustment bolts (b, c and d) that are within the area where the roller is present until the dial gauge indicates the required displacement. Fully fasten the mounting bolts where adjustment was performed.

Note) The displacement indicated on the gauge represents the preload per roller cage.

- (8) Slide the table as shown in Fig.2-2, and adjust the remaining adjustment bolts (a and e) in the same manner.

Note) When installing two or more units, first measure the tightening torque of the adjustment bolts for the first unit or the sliding resistance of the first unit. Then, install the second (and later) unit so that its/their tightening torque(s) or sliding resistance(s) equal(s) that of the first unit. In this way, almost uniform preloads can be provided.

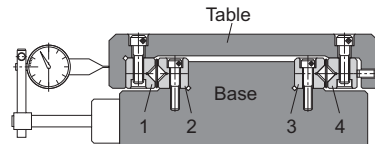

Fig.1 Installation of the Cross Roller Guide

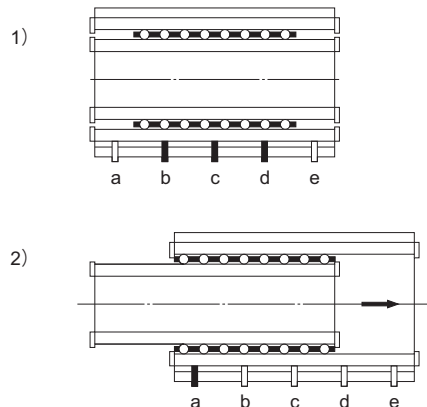
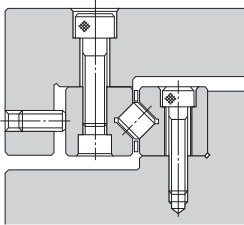

Fig.2 Sequence of Tightening the Adjustment Bolts

## Example of Clearance Adjustment

Design the adjustment bolt so that it presses the rail on the same level as the roller.



Normally, press the rail with the adjustment bolt.

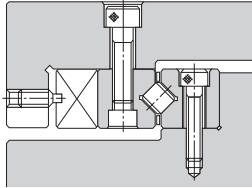

When a certain level of accuracy and rigidity is required, use a presser plate.

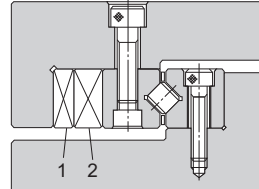

When high accuracy and high rigidity are required, use tapered gibs 1 and 2.

Fig.3 Example of Clearance Adjustment

## Preload

An excessive preload may cause indentation, shorten the service life or cause trouble. The permissible preload per roller cage is indicated in the specification table. Tighten the adjustment bolts while monitoring the displacement of the roller contact area.

## Accuracy of the Mounting Surface

To achieve a high level of running accuracy, it is also necessary to establish a certain level of accuracy in parallelism and straightness. Preferably, the parallelism and the flatness of the rail-mounting surface should be finished by grinding or similar machining to at least the same degree as the parallelism of the rail (see **A7-7**). Also, mount the rail so that it closely contacts the mounting surface.

## Dedicated Mounting Bolt

To mount the rail where normal clearance is to be adjusted, use the screw hole drilled on the rail as shown in Fig.1. The holes of the bolt ( $d_1$  and  $D_1$ ) must be machined so that they are greater by the adjustment allowance.

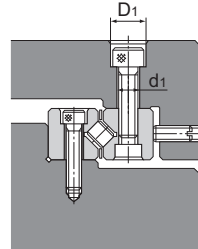

Fig.1

If it is inevitable to adopt a mounting method like the one shown in Fig.2 for a structural reason, use the dedicated mounting bolt (S) indicated in Fig.3.

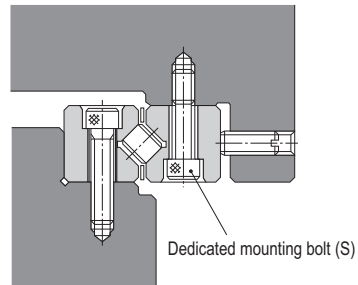

Fig.2

Table1 Dedicated Mounting Bolt

Unit: mm

Model No.	S	d	D	H	L	B	Mass [g]	Supported rail
S 3	M3	2.3	5	3	12	2.5	1	V3
S 4	M4	3.1	5.8	4	15	3	2	V4
S 6	M5	3.9	8	5	20	4	4	V6
S 9	M6	4.6	8.5	6	30	5	5	V9
S 12	M8	6.25	11.3	8	40	6	15	V12
S 15	M10	7.9	13.9	10	45	8	27	V15
S 18	M12	9.6	15.8	12	50	10	43	V18

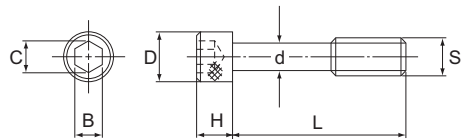

Fig.3 Dedicated Mounting Bolt

## Model Number Coding

Model number configurations differ depending on the model features. Refer to the corresponding sample model number configuration.

### [Cross Roller Guide/Ball Guide]

#### ● Models VR and VB

**VR1 M -30 H × 8Z**

No Symbol:  
Carbon steel  
(standard)

M: Stainless steel

H : High accuracy grade  
P : Precision grade

Number of rollers or balls

Dedicated rail dimension in mm (example of indication for a combination of different overall lengths: 40/50)

Combined model number (for Ball Guide: VB)

Note) "One set" in the model No. above indicates a combination of four rails and two cages.

- Dedicated rail only

**V6 -200**

Model No. Dedicated rail dimension in mm

- Roller cage only

**R6 × 13Z**

Model number Number of rollers or balls  
(Roller : R  
Ball : B)

- Dedicated mounting bolt

**S6**

Model No. For the compatibility chart, see **A7-30**

## Notes on Ordering

### [Order units]

“One set” of cross roller guides or ball guides denotes a combination of four rails and two cages.

### ● Sample cross roller guide and ball guide orders

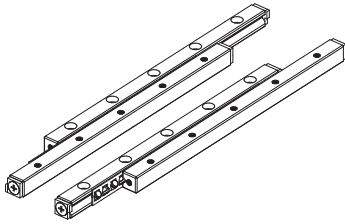

VR12 -400 P × 14Z 1 set

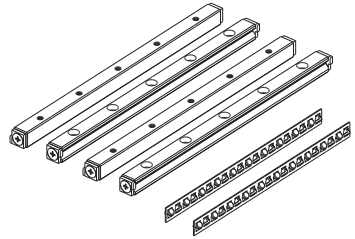

1 set consists of 4 rails and 2 cages

Note) For information on rail and cage product combinations other than those listed in the specification tables, contact THK.

## Precautions on Use

## Cross Roller Guide/Ball Guide

### [Handling]

- (1) Do not disassemble the parts. This will result in loss of functionality.
- (2) Take care not to drop or strike the Cross Roller Guide/Ball Guide. Doing so may cause injury or damage. Giving an impact to it could also cause damage to its function even if the product looks intact.
- (3) When handling the product, wear protective gloves, safety shoes, etc., as necessary to ensure safety.

### [Precautions on Use]

- (1) Prevent foreign material, such as cutting chips or coolant, from entering the product. Failure to do so may cause damage.
- (2) If the product is used in an environment where cutting chips, corrosive solvents, water, etc., may enter the product, use bellows, covers, etc., to prevent them from entering the product.
- (3) If foreign material such as cutting chips adheres to the product, replenish the lubricant after cleaning the product.
- (4) Do not use the product at temperature of 100°C or higher.
- (5) Micro-strokes tend to obstruct oil film to form on the raceway in contact with the rolling element, and may lead to fretting corrosion. Take consideration using grease offering excellent fretting prevention. THK also recommends periodically executing a full stroke with the unit to ensure that the raceway and balls are coated with lubricant.
- (6) Do not use undue force when fitting parts (pin, key, etc.) to the product. This may generate permanent deformation on the raceway, leading to loss of functionality.
- (7) Using the product with some of the rolling elements missing may cause damage at an early stage.
- (8) If any of the rolling elements falls, contact THK instead of using the product.
- (9) Insufficient rigidity or accuracy of mounting members causes the bearing load to concentrate on one point and the bearing performance will drop significantly. Accordingly, give sufficient consideration to the rigidity/accuracy of the housing and base and strength of the fixing bolts.

### [Lubrication]

- (1) Thoroughly wipe off anti-rust oil and feed lubricant before using the product.
- (2) When lubricating the product, apply grease directly on the raceway and stroke the product several times to let the grease spread inside.
- (3) Do not mix different lubricants. Mixing greases using the same type of thickening agent may still cause adverse interaction between the two greases if they use different additives, etc.
- (4) When using the product in locations exposed to constant vibrations or in special environments such as clean rooms, vacuum and low/high temperature, use the grease appropriate for the specification/environment.
- (5) The consistency of grease changes according to the temperature. Take note that the slide resistance of the Cross Roller Guide/Ball Guide also changes as the consistency of grease changes.
- (6) After lubrication, the slide resistance of the Cross Roller Guide/Ball Guide may increase due to the agitation resistance of grease. Be sure to perform a break-in to let the grease spread fully, before operating the machine.
- (7) Excess grease may scatter immediately after lubrication, so wipe off scattered grease as necessary.



- (8) The properties of grease deteriorate and its lubrication performance drops over time, so grease must be checked and added properly according to the use frequency of the machine.
- (9) The greasing interval varies depending on the use condition and service environment. Set the final lubrication interval/amount based on the actual machine.

### [Installation]

If the counterbore hole on the Cross Roller Guide is being used to anchor the rail, use a hexagonal-head bolt (JIS B 1176). However, for the models listed in Table1, THK's recommendations for screws are shown.

Table1 Anchoring screws

Model	Type	Nominal name of screw × pitch
VR1	No. 0 pan-head screw (class 3)	M1.4×0.3
VR2	Pan Head Screw	M2×0.4

- Japan Camera Industry Association Standard JCIS 10-70 Phillips screw for precision equipment (No. 0 screw)
- Phillips pan head screw JIS B 1111

### [Rail Length]

The roller cage and the ball cage move half the travel distance of the table in the same direction.

To prevent the cage from overhanging from the raceway base when the cage length is " $l$ " and the stroke length is " $l_s$ ", the rail length ( $L_k$ ) must be at least the following.

$$L_k \geq l + \frac{l_s}{2}$$

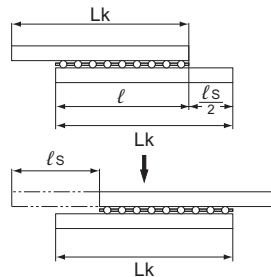

Fig.1

### [Offset of the Cage]

The cage, which retains the rollers (or balls), demonstrates extremely accurate motion. However, it may be offset as affected by driving vibrations, inertia or impact.

When desiring to use the product in a following condition, contact THK.

- Vertical use
- Pneumatic cylinder drive
- Cam drive
- High speed crank drive
- Under a large moment load
- Butting the guide's external stopper with the table

**[Stopper]**

Stoppers are attached to the rail ends in order to prevent the cage from falling off. Note, however, that frequently colliding the cage with the stopper may cause wear of the stopper and loosening of the stopper fastening screws, and may cause the cage to fall off.

**[Contamination protection]**

As a means to prevent foreign material from entering the Cross Roller Guide or the Ball Guide, contamination protection accessories for the side faces as shown in Fig.2 are available. For contamination protection in the front and rear directions, consider using a bellows or a telescopic cover.

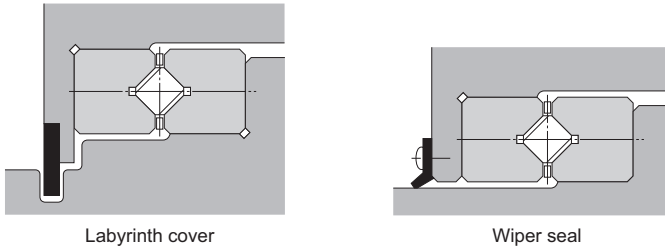

Fig.2 Contamination Protection Methods

**[Storage]**

When storing the Cross Roller Guide•Ball Guide, enclose it in a package designated by THK and store it in a room in a horizontal orientation while avoiding high temperature, low temperature and high humidity.

**[Disposal]**

Dispose of the product properly as industrial waste.